

Journey from Closed to Open: Lessons Learned from Open Sourcing Sound Open Firmware

Liam Girdwood

Open Source Firmware Conference Europe 2018

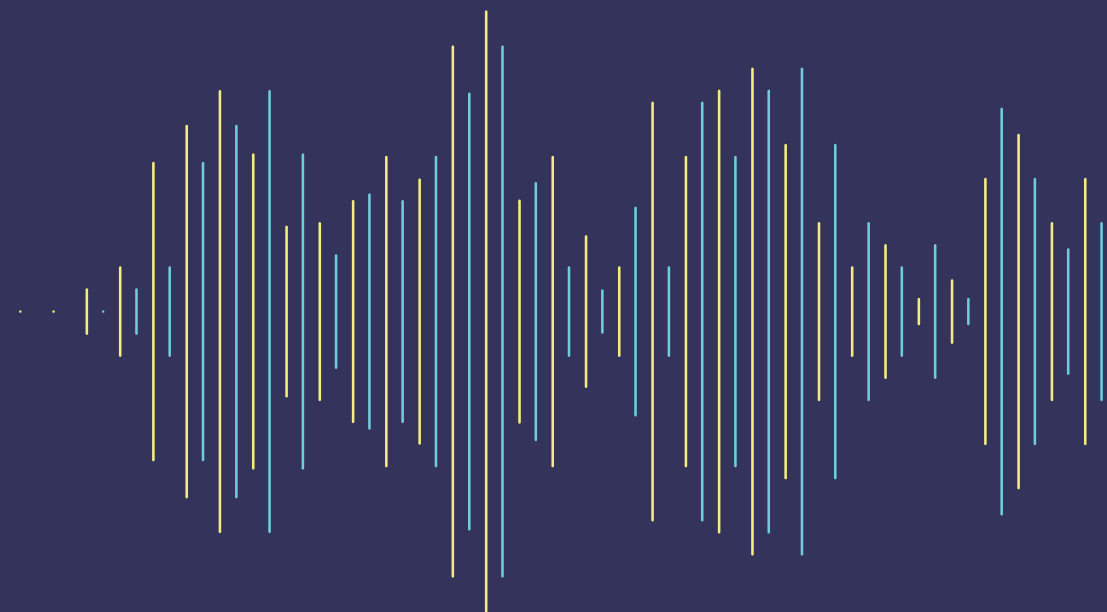

Mission

1. Inspire others to open source their firmware.
2. Show how firmware can be open sourced.
3. Discuss challenges common with open source firmware.
4. Explain SOF architecture.



About Me

- Employed by Intel as a software architect.
- Linux* user and engineer since 1994.
- Developed AsoC and PMIC abstraction layers.
- Linux audio engineer since 2003.
- Working on audio DSP's since 2008.
- Working on SOF since 2015.



*Other names and brands may be claimed as the property of others.



**Sound Open Firmware is an open
source audio digital signal
processing firmware and driver
infrastructure.**



The Dark Ages

**Darkness due to lack of source code*



Closed Source Firmware

- Historically, the standard practice among firmware development teams with a few exceptions.
- Often seen as a black box by integrators and driver and user space developers.
 - Makes it more difficult to debug problems in other areas of the stack.
 - Impossible for upper stack developers to debug hardware problems.
- Usually developed alongside a single OS specific driver.
- Documentation never truly matches or keeps up with firmware source code.

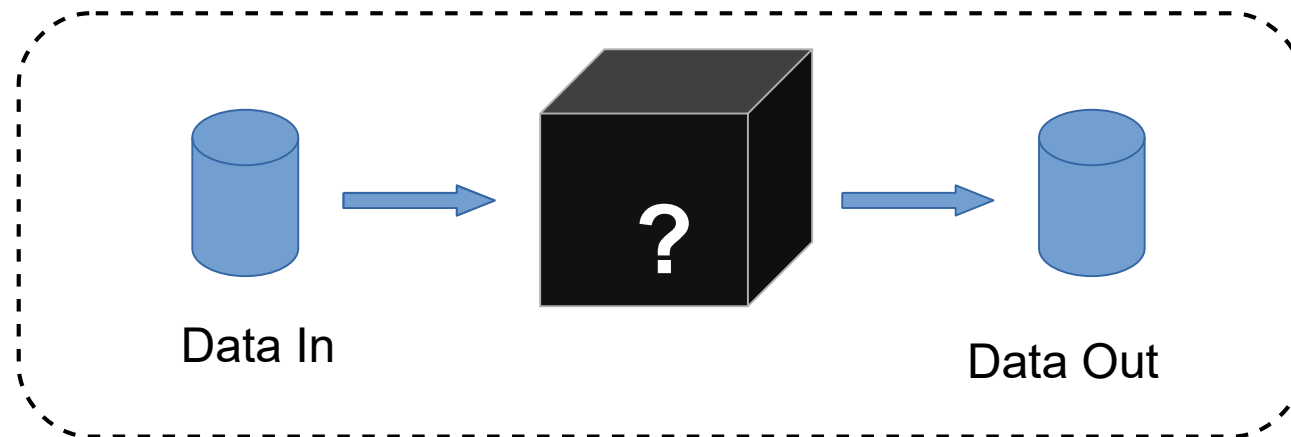

Changing Course

Factors influencing open sourcing.



Market Drivers



- Demand for speech and voice authentication and recognition applications and technologies.
- Impact of AI on accuracy of speech and voice recognitions.
- Growth in voice control-based devices in consumer and enterprise markets.

Audio, speech, and voice has become ubiquitous.

Open Source Hardware

- Minnowboard Project
- Open Source Hardware
 - Baytrail CPU, dual core @1.33GHz, 2GB DDR
 - Tensilica Xtensa audio DSP @ 400MHz
 - Open schematics, PCB layout, BOM
- Open source Software
 - Full open source Linux* software stack
- Open source Firmware
 - Open source coreboot BIOS
 - NO open source audio DSP firmware!



*Other names and brands may be claimed as the property of others.



Minnowboard DSP Architecture

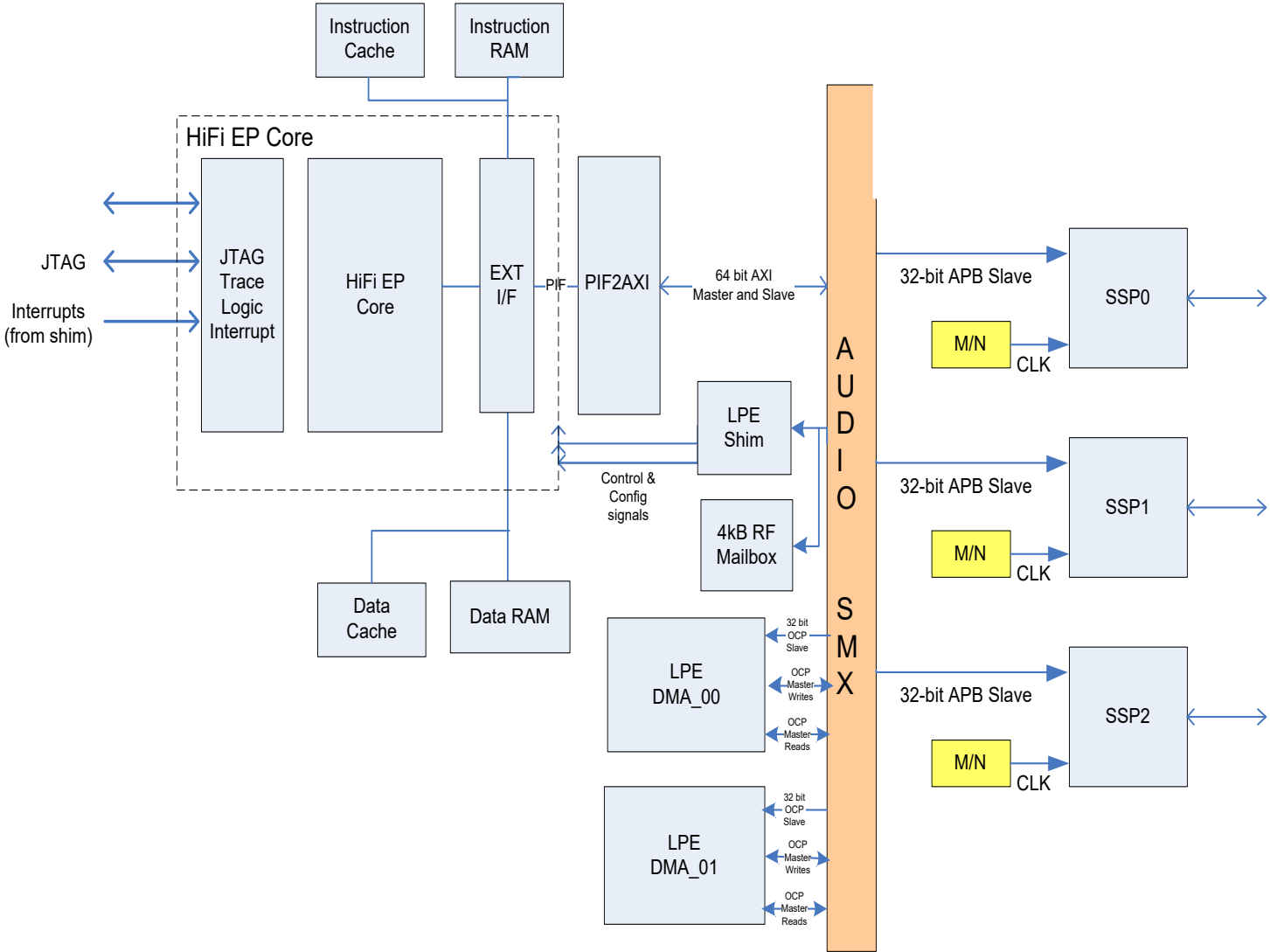

- Xtensa HiFi 2EP core
- 96kB Instruction RAM
- 168kB Data RAM
- 2 * DMACs
- 3 * I2S ports
- PCI device from host OS



Challenges Ahead

Be prepared!



Political Challenges

- Intel policy for audio DSP firmware was historically closed source.
- Most colleagues were initially either strongly in favor or strongly against.
 - Fears around disclosing IP.
 - How do we add value?
- Be prepared to fight the same battle more than once.
- Build ground swell of opinion and facts behind open source.
- It helps if you have proof of concept code - “skunkworks”!
- Tell the world about your project!

“You may have to fight a battle more than once to win it.”

Margaret Thatcher



Technical Challenges - Compiler

- Xtensa ISA differs between cores adding complexity for compilers.
- Cadence provide an optimising compiler for Xtensa
 - Commercial license for some targets \$\$\$
 - Free for some targets like Minnowboard :)
- Need open source compiler for community.
 - GCC supports xtensa base ISA
 - GCC does not support xtensa SIMD/MLIW

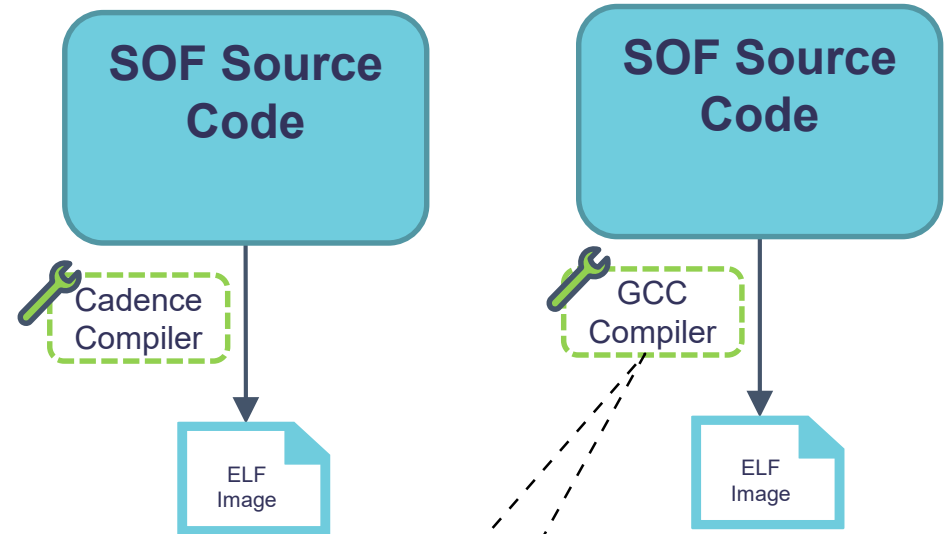

Add GCC support for Minnowboard xtensa ISA.

Technical Challenges – Image Builder

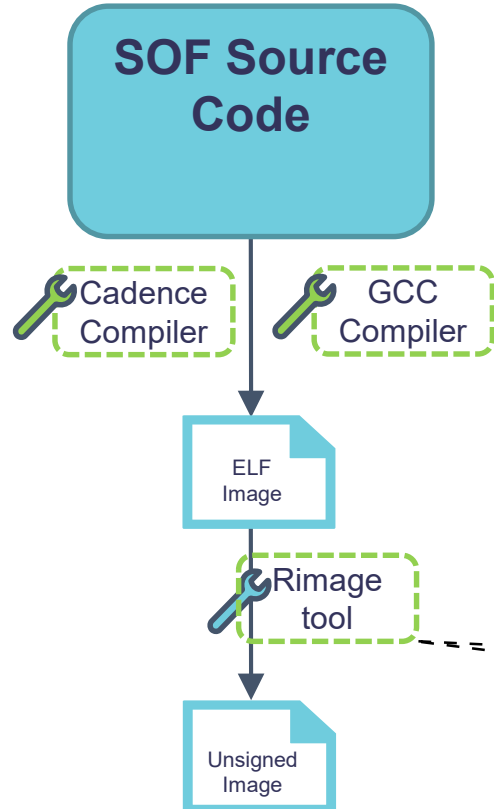

- Compilers generate ELF images.
- ELF images don't run on bare metal.
- ELF image needs converted to binary image format for loading into DSP memories.
- Need to have tools that can convert ELF to multiple firmware image formats.

Create tool to convert ELF images into multiple different image formats.

Should be able to run code now !

Technical Challenges – DSP Emulator

- Code not easy to debug
 - No debugger (yet)
 - No printf();
 - JTAG can't be used – Intel only.
- Emulation can be used to debug bring up
- Qemu already supports base Xtensa ISA
- Qemu support added
 - Minnowboard DSP
 - Extra registers and instruction not in base ISA

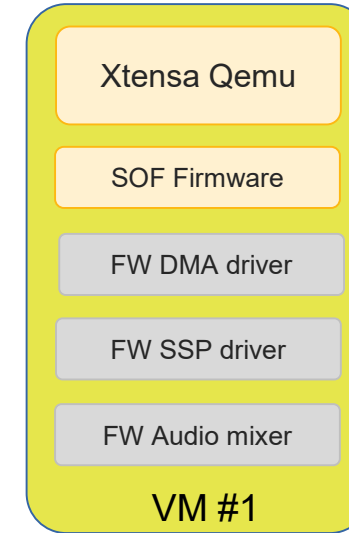

Technical Challenges – Heterogeneous Emulator

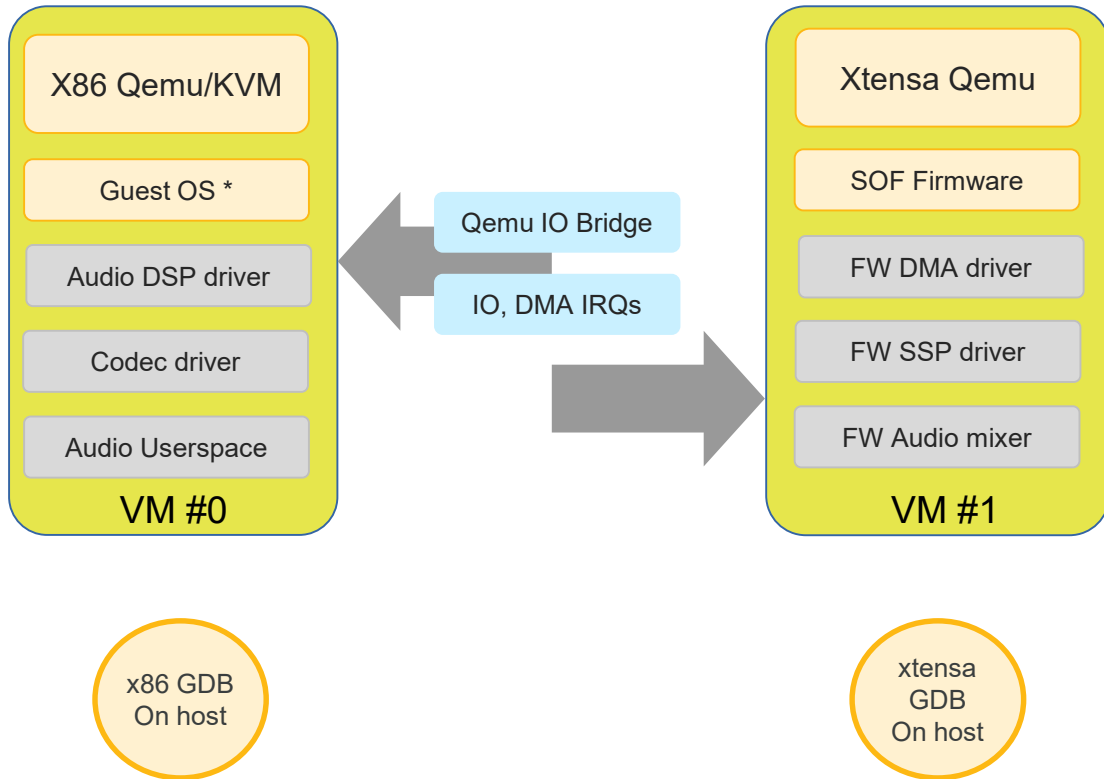

- Firmware must be debugged alongside driver.
- Qemu used to virtualise drivers and firmware together.
- Host side almost real time.
- DSP side emulated.

Technical Challenges – Code Signing

- Newer DSP hardware has security that validates firmware binaries.
- Code signing support was added to open source rimage tool.
 - PCKS #1.5
 - Openssl
- Created “public” private key to be used for developer hardware e.g. UP^2.
- Implications with GPLv3 “tivoization” clause.

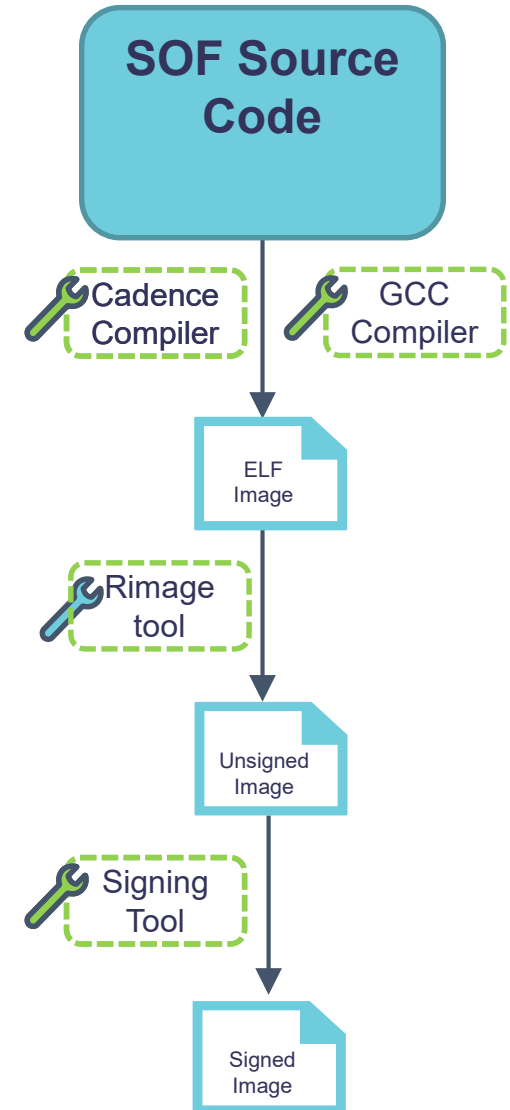

Hello World



Firmware Architecture

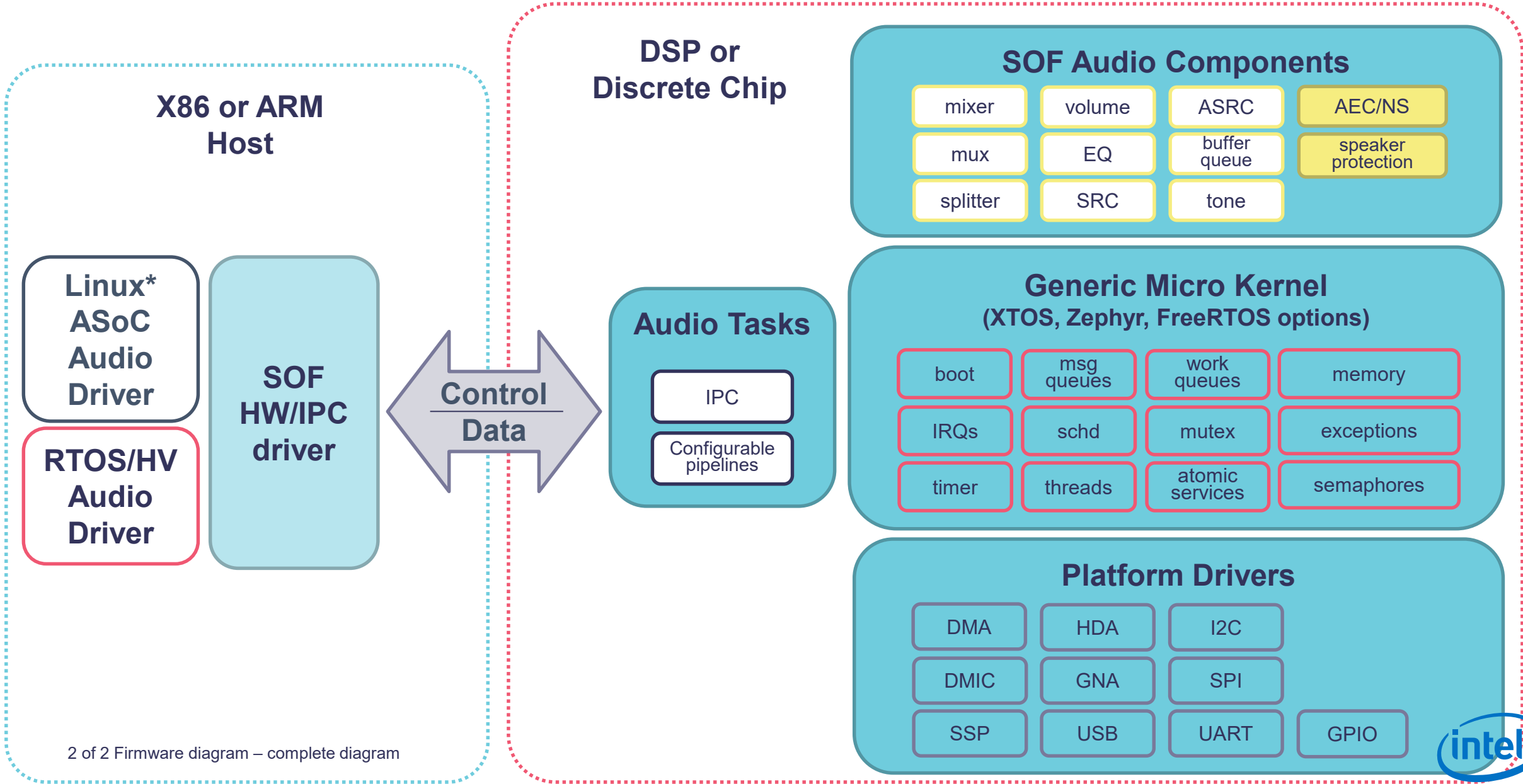

2 of 2 Firmware diagram – complete diagram

*Other names and brands may be claimed as the property of others.



Driver Architecture

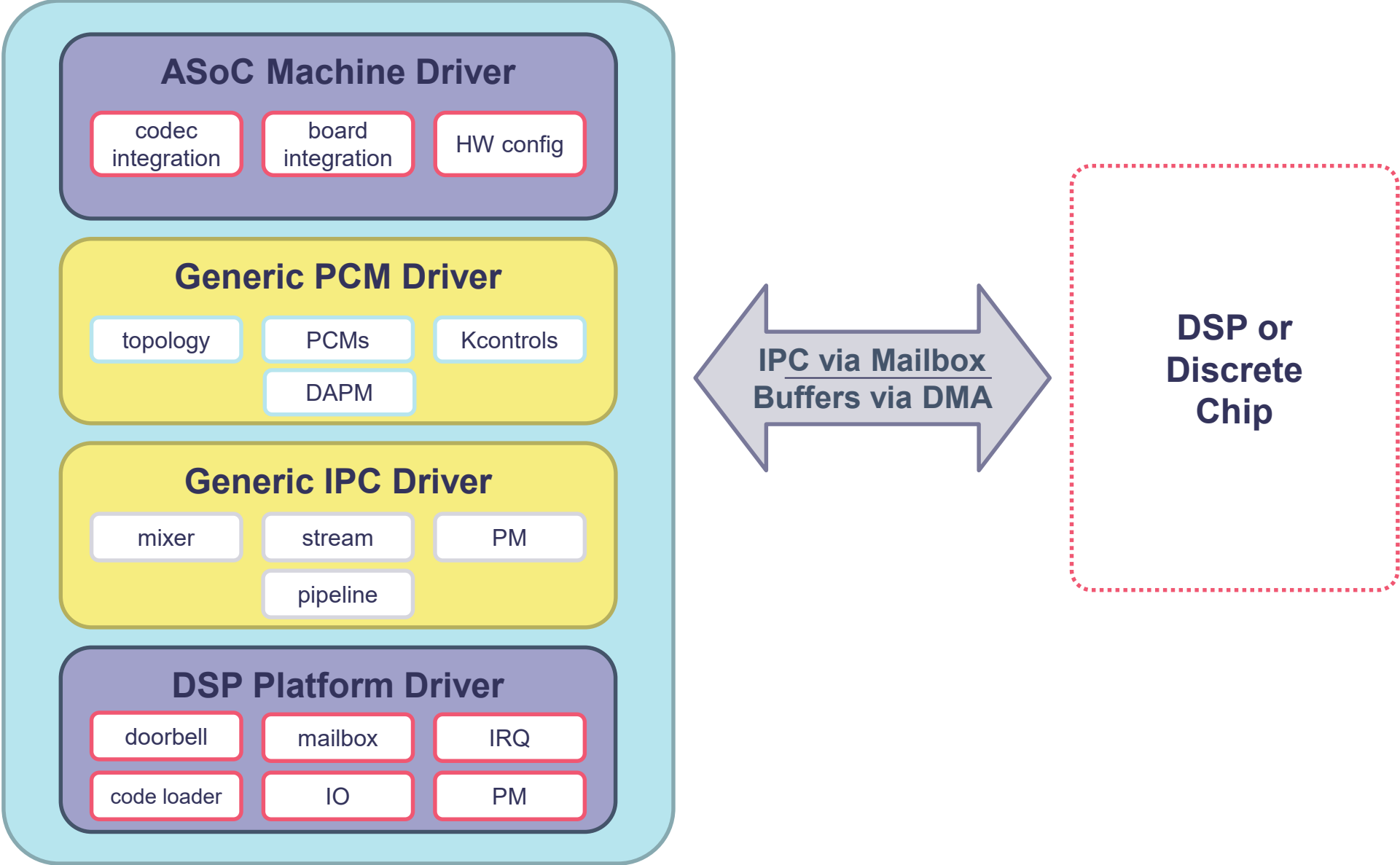

History

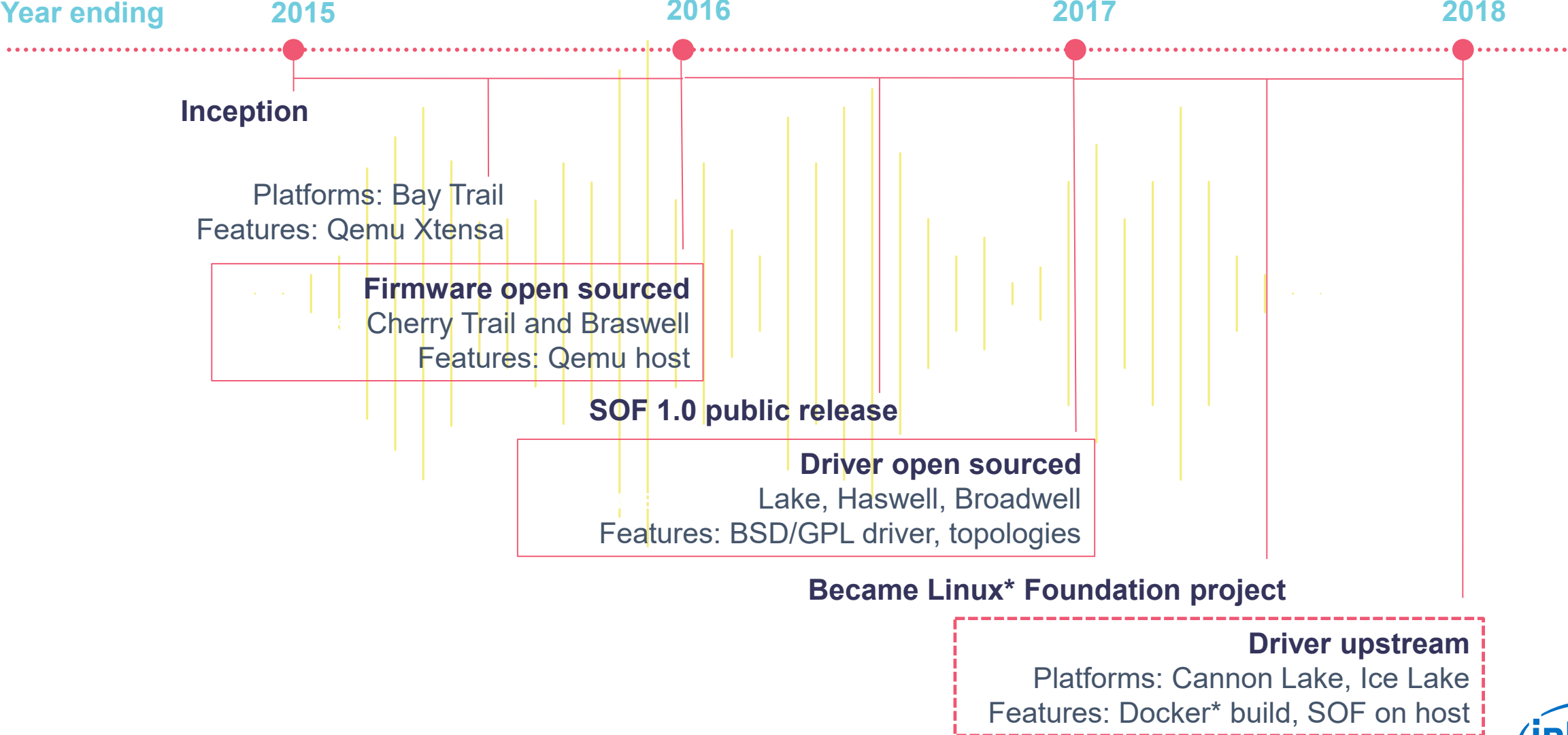

*Other names and brands may be claimed as the property of others.



Development Kit

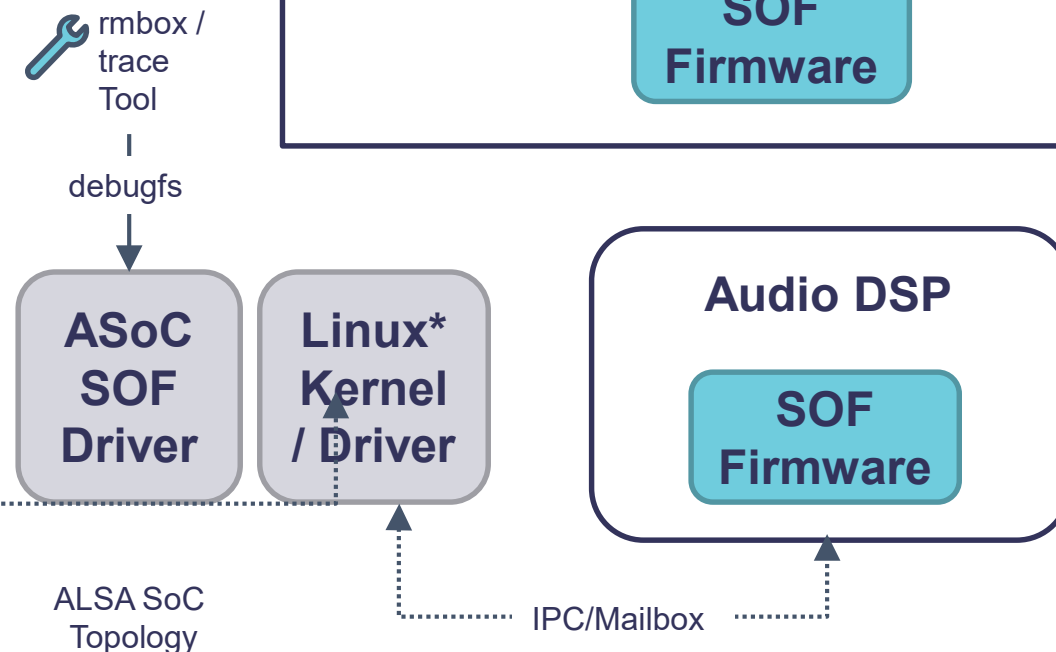
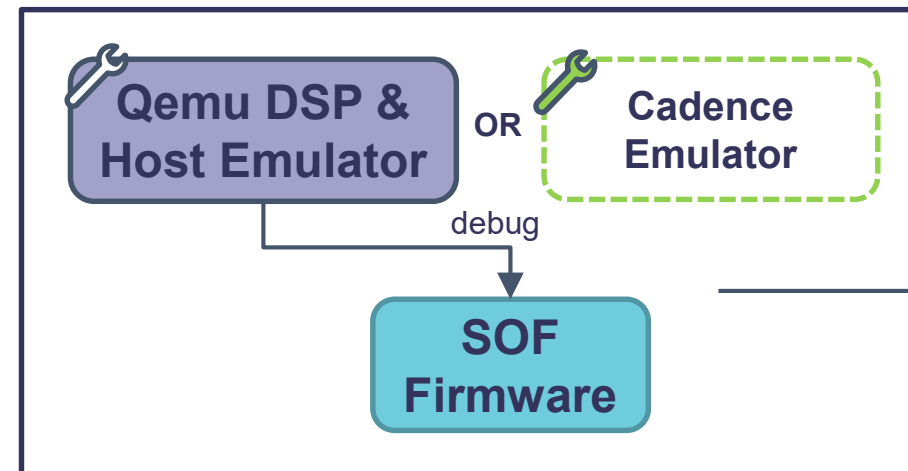
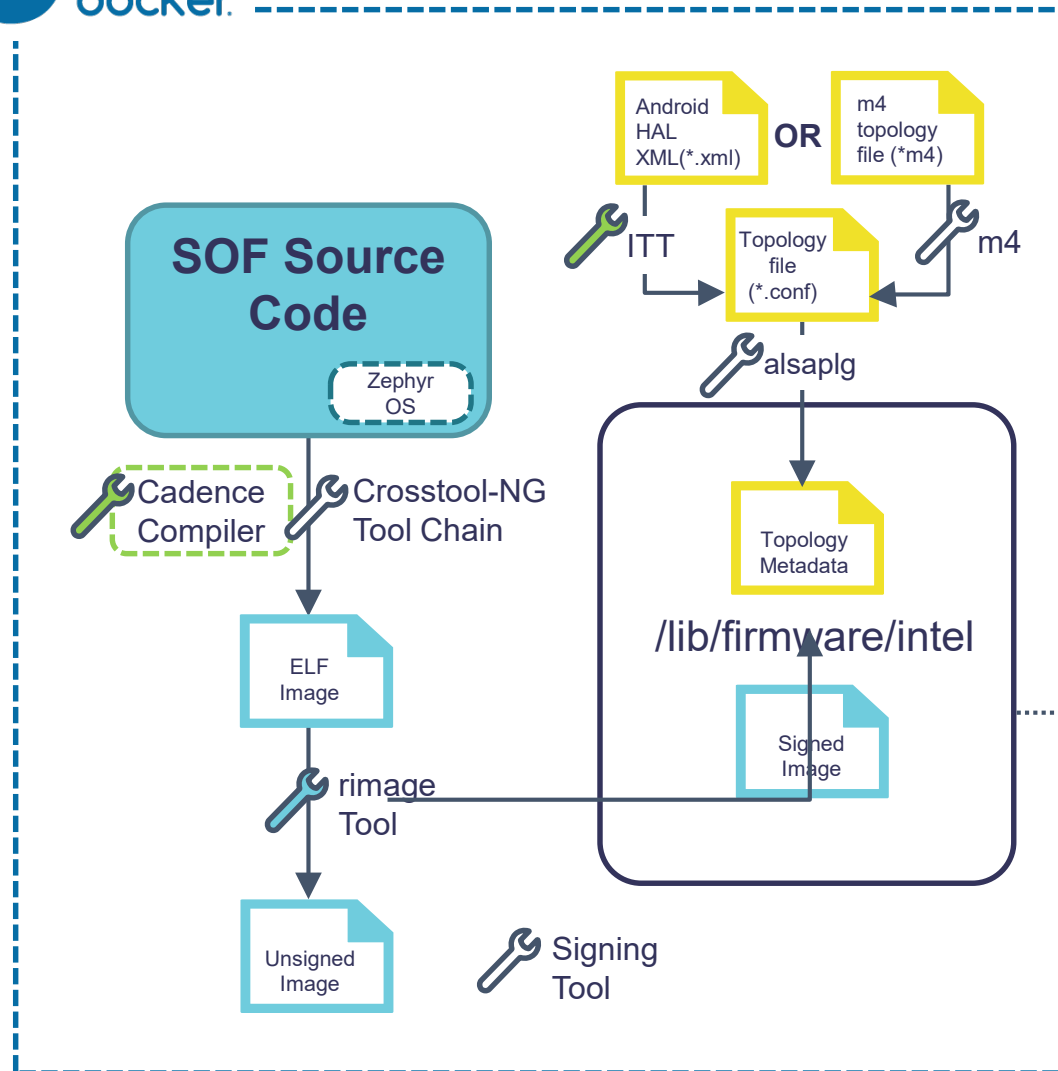

Note: Docker* contains only the open source components

SDK diagram – complete SDK

*Other names and brands may be claimed as the property of others.



Build a Community

- A healthy open source project needs a healthy community!
- Who embodies the community?
 - Commercial users who deploy in products.
 - Non commercial hobbyists.
 - Academics researching audio processing algorithms.
- Use external code hosting platforms like github, mailing lists, IRC, and wikis, and do development in public.
- Release patches and code “early and often”.
 - Don’t do infrequent code drops.
 - No “abandonware”.
- Accept patches from others.
- Accept bug reports from others.



Core Pillars

Open source · Community driven

Permissive¹

- BSD/MIT licensed firmware and topologies
- BSD/GPL dual licensed driver
- Firmware code changes can be private or up-streamed



Modular

- Configurable topology allows for flexible customizations
- Extendable using existing APIs to add custom or 3rd party binary modules
- Allows for custom ABIs between modules
- Develop and test out new modules before deploying onto target HW



Portable

- Platform, firmware OS, DSP architecture agnostic
- Portable to other host platform and DSP architectures
- Extendable to different real-time DSP OSEs
- Modifiable for any custom integrations

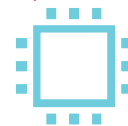

Tool-rich

- BSD/GPL licensed and proprietary tools available
- Includes toolchain, debugger, emulator, scripts, firmware creation tools
- Configurable builds using supported GNU GCC or proprietary toolchains
- Virtualize both DSP and host OS via QEMU
- Virtualize trace data in real time



¹: SDK tools are a mixture of BSD, GPL and proprietary licenses.

Thanks!

Q & A



Legal notices and disclaimers

- This document contains information on products, services and/or processes in development. All information provided here is subject to change without notice. Contact your Intel representative to obtain the latest forecast, schedule, specifications and roadmaps.
- Intel technologies' features and benefits depend on system configuration and may require enabled hardware, software or service activation. Learn more at intel.com, or from the OEM or retailer. No computer system can be absolutely secure.
- Tests document performance of components on a particular test, in specific systems. Differences in hardware, software, or configuration will affect actual performance. Consult other sources of information to evaluate performance as you consider your purchase. For more complete information about performance and benchmark results, visit <http://www.intel.com/performance>.
- Cost reduction scenarios described are intended as examples of how a given Intel-based product, in the specified circumstances and configurations, may affect future costs and provide cost savings. Circumstances will vary. Intel does not guarantee any costs or cost reduction.
- Statements in this document that refer to Intel's plans and expectations for the quarter, the year, and the future, are forward-looking statements that involve a number of risks and uncertainties. A detailed discussion of the factors that could affect Intel's results and plans is included in Intel's SEC filings, including the annual report on Form 10-K.
- The products described may contain design defects or errors known as errata which may cause the product to deviate from published specifications. Current characterized errata are available on request.
- No license (express or implied, by estoppel or otherwise) to any intellectual property rights is granted by this document.
- Intel does not control or audit third-party benchmark data or the web sites referenced in this document. You should visit the referenced web site and confirm whether referenced data are accurate.
- Intel and the Intel logo are trademarks of Intel Corporation in the U.S. and/or other countries. *Other names and brands may be claimed as the property of others.

